

WATERFALL RAINFALL MIST THERMOSTATIC LED PHONE CONTROLLED RECESSED CEILING MOUNT GOLD SHOWER SYSTEM WITH JETTED BODY SPRAYS AND HANDHELD SHOWER SPECIFICATIONS

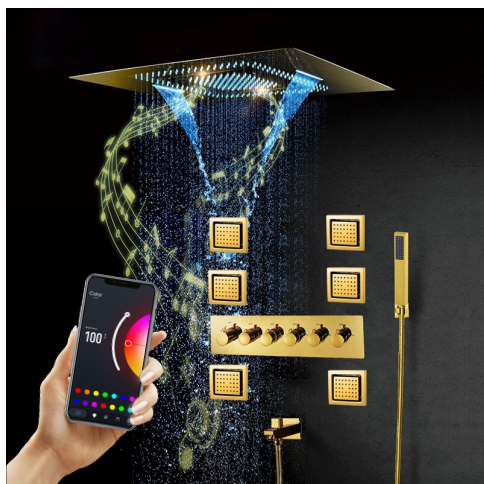

Shower Head

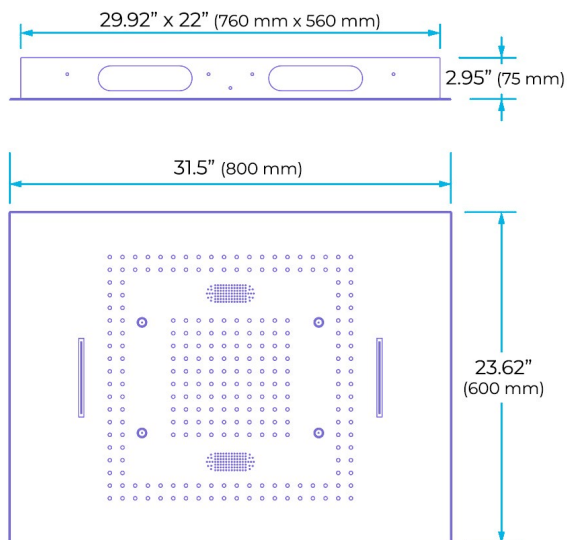

Product shown is only for installation display purpose

- Shower Panel /Hose Material: 304 Stainless Steel
- Shower Head Size: 800*600 mm
- Showerheads Install: Embedded Ceiling Mounted
- Concealed Mixer Install: Wall-Mounted
- LED Shower Head Functions: Rainfall, Waterfall, Mist
- Water Pressure: 0.3 MPA
- Water Flow: 16L/min~28L/min
- Shower Accessories Material: Brass
- LED Light: Need to Connect Power
- Shower Hose Length: 1.5M
- AC: 100-265V 50/60Hz
- Music: Need Bluetooth

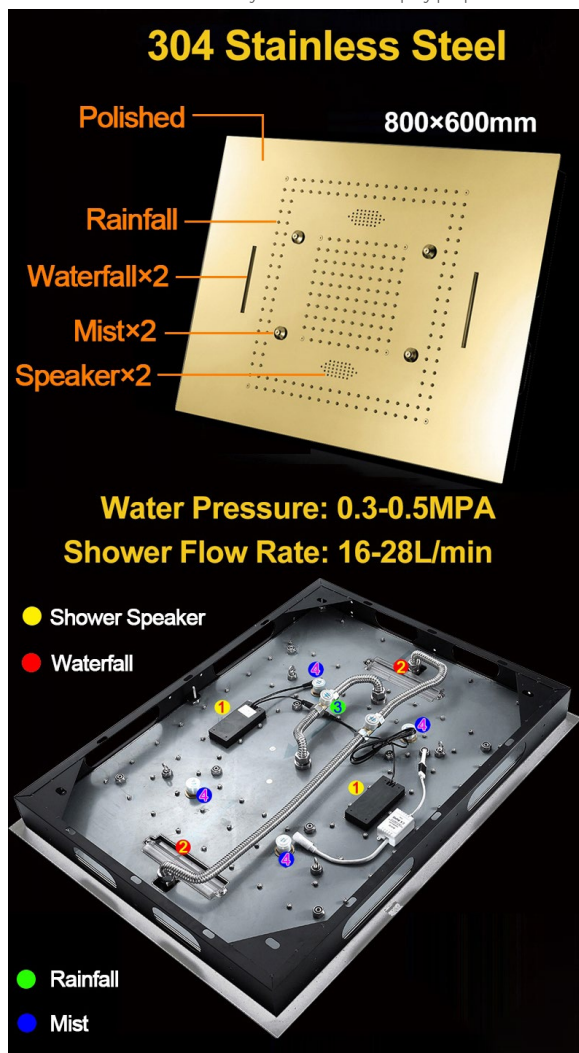

All dimensions and specifications are nominal and may vary. Use actual products for accuracy in critical situations.

Shower Mixer

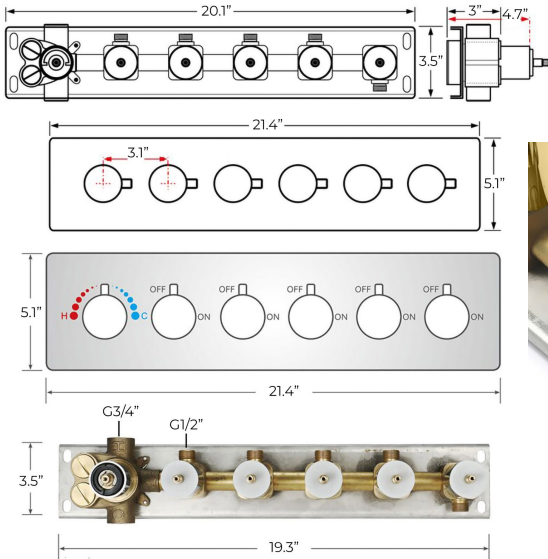

Product shown is only for installation display purpose

Hand Shower

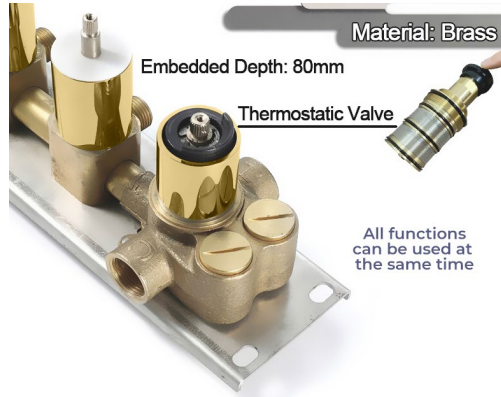
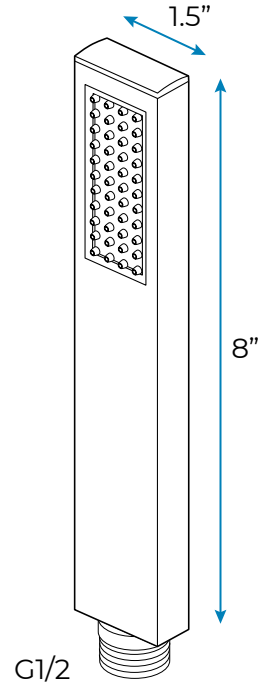

Shower Mixer Connections

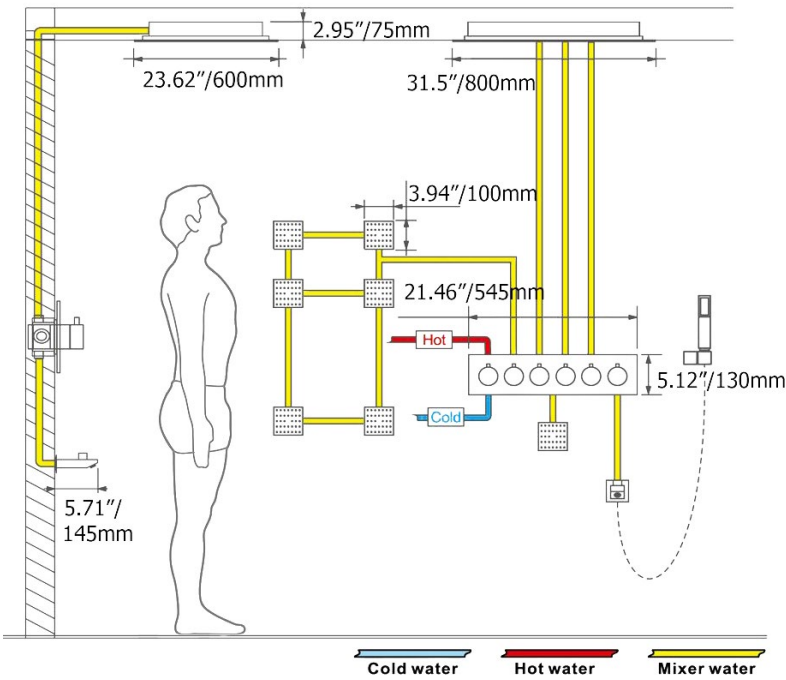

Spout

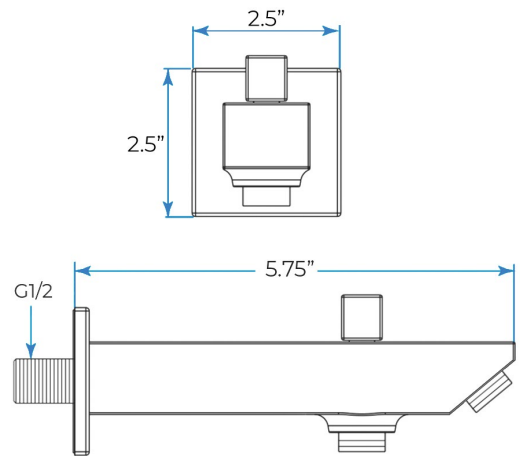

Body Jet

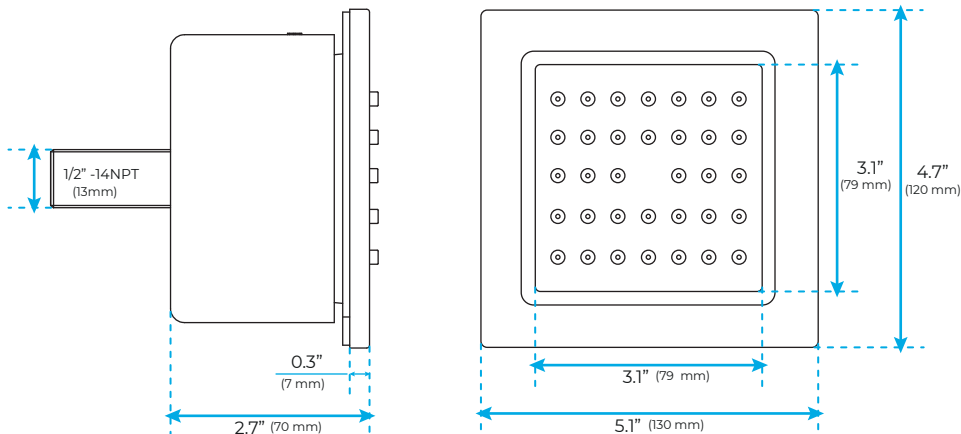

FEATURES

- Material: Brass
- Base Plate Height: 5-1/8"
- Base Plate Width: 5-1/8"
- Jet Surface Area: 3-1/8"
- Surface Depth: 1/4"
- Adjustment Angle: 5°
- Male NPT Connection: 1/2"
- Maximum Flow Rate: 2.5 GPM (9.5L/min) max @ 80 psi